

Irideon AR250

instructions
manual

Index

1. Packaging	Page. 4
2. Transportation	.. 4
3. Important safety information	.. 5
4. Opening up the projector	.. 6
5. Lamp: installation and replacement	.. 7
6. Operating voltage and frequency	.. 8
7. Installation	.. 9
7.1 Installing the unit in weather-protected areas	.. 9
7.2 Installing the unit in exposed areas	.. 9
7.3 Warning	.. 9
8. Mains connection	.. 10
9. Signal connection	.. 11
9.1 Automated operation - "solo"	.. 11
9.2 Operation via DMX 512	.. 11
9.3 Synchronising multiple AR 250 fixtures without DMX signal	.. 12
10. Powering up	.. 13
11. DMX addressing	.. 14
12. Display panel functions	.. 15
12.1 Operating modes "mode"	.. 15
12.2 Functions "func"	.. 16
12.3 Parameters and testing "meas"	.. 17
12.4 Quick guide to menu navigation	.. 18
12.5 Rapid scrolling	.. 18
12.6 Double pressing the menu button	.. 18
13. Setting the unit to function automatically "solo"	.. 19
14. DMX 512 functions	.. 20
15. Operating multiple AR 250 fixtures without DMX 512	.. 20
15.1 "Master" unit	.. 21
15.2 "Slave" units	.. 21
16. Resetting the counter	.. 22
17. Mechanical adjustments	.. 22
17.1 Tilt adjustment	.. 22
17.2 Altering beam angles by using lenses	.. 23
18. Altering the operating voltage and frequency	.. 25
18.1 Selecting the operating voltage on the autotransformer	.. 25
18.2 Selecting the operating frequency on the power supply	.. 26
19. Opening the front of the projector (Reserved for technical staff)	.. 27
20. Thermal protection	.. 28
21. Servo-controlled fans	.. 28
22. Maintenance	.. 28
23. Electronic motor alignment	.. 29
24. Error messages	.. 30
25. Spare parts	.. 30

Congratulations on having purchased an **ETC** product. You have assured yourself of a fixture of the highest quality, both in componentry and in the technology used.

1. Packaging

Following the instructions and procedures outlined in this manual will ensure the maximum efficiency of this product for years to come.

Open the packaging and ensure that no part of the equipment has suffered damage in transit. In case of damage to the equipment, contact your carrier immediately by telephone or fax, following this with formal notification in writing.

packing list

Ensure the packaging contains:

1 AR 250

- 1 owner and installation manual
- 3 optional prismatic lenses
- 1. lamp ETC PN RT172 Lamp MSD250W/2

2. Transportation

The **AR 250** should be transported in its original packaging or in an **ETC** approved flight case. During transportation, the packaging or flight case should ensure no movement of the unit. Failure to do so may result in damage to the unit.

3. Important safety information

Fire prevention:

1. **AR 250** utilizes a Philips MSD 250W/2 lamp or equivalent; the use of any other lamp is not recommended and will null and void the fixtures warranty.
2. Never locate the fixture on any flammable surface.
3. Minimum distance from flammable materials: 0.5m (1.6').
4. Minimum distance from the closest illuminable surface: 2.0m (6.6').
5. Replace any blown or damaged fuses only with those of identical values. Refer to the schematic diagram if there is any doubt.
6. Connect the projector to mains power via a thermal magnetic circuit breaker.

Prevention against electric shock

1. High voltage is present in the internals of the unit. Isolate the projector from mains supply prior to performing any function which involves touching the internals of the unit, including lamp replacement.
2. For mains connection, adhere strictly to the guidelines outlined in section 7 of this manual.
3. The level of technology inherent in the **AR 250** requires the use of trained technicians
4. A good earth connection is essential for proper function of the projector.
Never operate the unit without proper earth connection.

Protection against ultraviolet radiation

1. Never turn on the lamp if any of the lenses, filters, or the housing is damaged; their respective functions will only operate efficiently if they are in perfect working order.
2. Never look directly into the lamp when it is operating.

Safety:

1. The projector should always be installed with bolts, clamps, and other fixings which are sufficiently rated to support the weight of the unit.
2. Always use a secondary safety chain of a sufficient rating to sustain the weight of the unit in case of the failure of the primary fixing point.
3. The external surface of the unit, at various points, may exceed 150°C (302°F).
Warning: Never handle the unit until at least 10 minutes after the lamp is turned off.
4. Never install the fixture where unauthorised and untrained personnel may tamper with it.
5. Always replace the lamp if any physical damage is evident.
6. Never install the fixture in an enclosed area lacking sufficient air flow; the ambient temperature should not exceed 35°C (95.0°F).
7. A hot lamp may explode. always wait for at least 10 minutes to elapse after the unit has been turned off prior to attempting to replace the lamp.
Always wear suitable hand protection when handling the lamp.

Protection rating of the body against liquids and solids:

1. The fixture has an IP 44 protection rating; this indicates that a particle larger than 1mm (.04") cannot penetrate the unit and that it is totally protected against showers of water.
The protection rating allows the fixture to be utilized in an exposed location in inclement weather as long as it is installed according to the instructions located in section **7.2 "Installing the unit in exposed areas"**.

4. Opening the projector

Many of the operations described later in this manual can only be performed with the projector housing opened.



Attention!

Turn off the power prior to opening up the unit.

The fixture's internal temperature may reach 250°C (482°F) after 5 minutes, with a maximum peak of 350°C (662°F). Ensure the lamp is cold prior to attempting removal. The fixture should be allowed to stand and cool for 10 minutes prior to its removal.

To access the internals of the projector, proceed as follows:

- 1) Using a Philips head screwdriver, loosen and remove the 11 screws (A) which affix the rear housing (B) of the projector body.



- 2) Remove the cover (B) from the central seal.

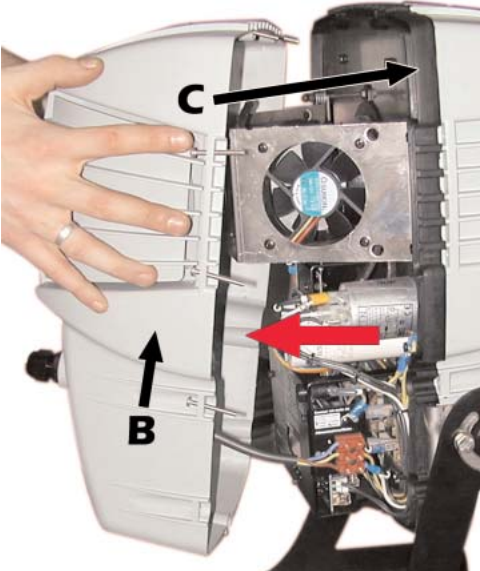

- 3) You should now have access to the internals of the unit and may carry out the instructions detailed below.

5. Lamp: installation and replacement

The **AR 250** utilizes a Philips MSD 250W/2 or Philips MSD 250W lamp or equivalent.
The lamp is available from your authorised **ETC** sales agent:

MSD 250/2

power	250 w
luminous flux	18.000 lm
color temperature	8.500° K
base	GY 9,5
approximate lamp life	2000 hours

MSD 250

power	250 w
luminous flux	18.000 lm
color temperature	6.700° K
base	GY 9,5
approximate lamp life	2000 hours

To access the lamp, you should proceed as described in section 4 of this manual.

MSD are part of the mercury vapour family of discharge lamps and must be handled with great care. the lamp operates at high pressure, and the slight risk of explosion of the lamp exists if operated over its recommended life.
We recommend, therefore, that the lamp be replaced within the manufacturer's specified lamp life.

3) Locate the lamp assembly and, using a Philips head screwdriver, loosen the three screws (**C**) which affix the assembly.



4) Remove the lamp assembly (**D**).

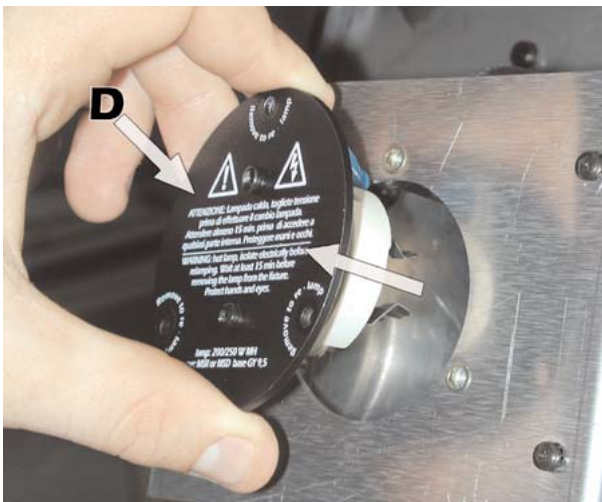

5) Locate the lampholder (**E**)

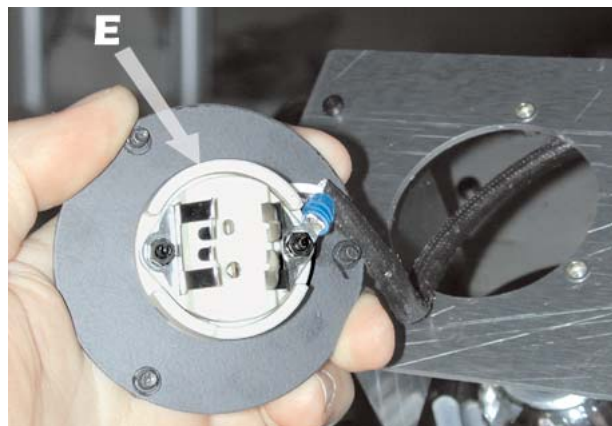

English

6) Insert the lamp into the lampholder (E).

The lamp used is manufactured from quartz glass and should be handled with care. Always adhere to the instructions supplied in the lamps packaging. Do not touch the glass directly, use the cloth provided with the lamp. The GY 9,5 lampholder is asymmetrical in construction, with one pin larger than the other. Ensure that the pins are correctly aligned with the appropriate socket. **DO NOT USE UNDUE FORCE.** In case of difficulty, re-read the instructions and repeat the procedure.

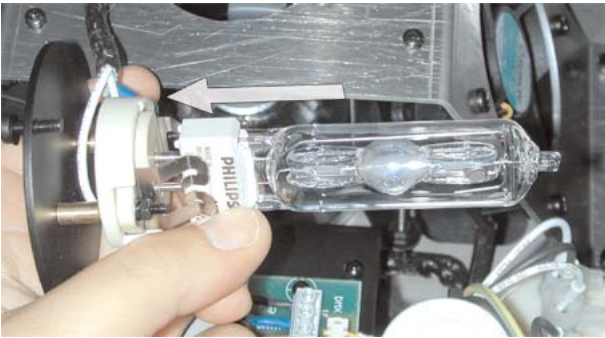

7) Replace the lamp assembly into its original position and replace and retighten the screws



Do not close the unit until all the operations have been performed on the display panel internal to the **AR 250**.

6. Operating voltage and frequency

The fixture may operate at voltages ranging from 100, 115, 208, 230 or 240V .at 50 or 60 Hz. Factory preset voltage is indicated on the sticker located on the base of the projector, as indicated in the following diagram.

factory set main at:	
<input type="checkbox"/> 100V	
<input type="checkbox"/> 115V	
<input type="checkbox"/> 208V	
<input checked="" type="checkbox"/> 230V	
<input type="checkbox"/> 240V	
<input checked="" type="checkbox"/> 50Hz	
<input type="checkbox"/> 60Hz	

If the specified voltage and frequency do not match those of the country in which you are operating, follow the instructions in section **18** of this manual. **"Altering the operating voltage and frequency"**
Incorrect voltage and frequency selection will detrimentally affect the operation of the projector.

7. Installation

Due to its high protection rating **AR 250** may be installed in a variety of locations, both indoors and in areas exposed to the elements.

7.1 Installing the unit in weather protected areas.

AR 250 may be situated in any mounting position when operated in sheltered areas.

In order to allow it to be installed in a variety of locations, the **AR 250** is provided with 5 mounting holes (**A**) of 13mm (0.51") on its base; for permanent and secure mounting on any surface.

If hanging the unit from ceiling or a structure, you may utilize the holes (**A**) which allow for the attachment of a "c" clamp at any position through 360°. The structure from which the unit is hung should be of sufficient rating to hold the weight of the unit, as should any clamps used to hold the unit.

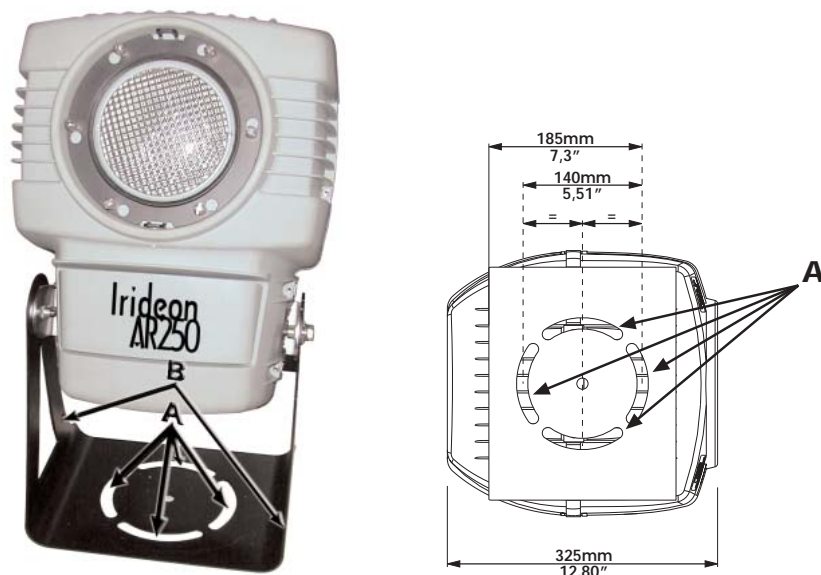

7.2 Installing the unit in exposed areas

The **AR 250** may be situated in several mounting positions when installed in an exposed area, thanks to its IP 44 protection rating. To ensure proper installation, however, there is a simple guideline to follow:



Attention!

As shown in the diagram, base of the unit must always be facing the ground.

The **AR 250** may be adjusted from -45° to +90°. without having to move any other component except the head of the fixture.. Installation in any position other than with the base down, will cause the projector to not perform with its maximum protection rating.

Installing the unit incorrectly may cause damage to occur and will immediately void the warranty.

7.3 Warning safety chain

When hanging the **AR 250** we recommend the use of a safety chain affixed to the appropriate hole (**B**) on the yoke of the **AR 250** and to the suspension device.

This secondary safety attachment should be done using either a metal wire rope or a metal chain, both suitably rated for the purpose.

risk of fire

Every projector produces heat, and should therefore be installed in a well-ventilated position. The minimum distance from flammable materials: 0.5m (1.64'). The minimum distance from the object being illuminated: 2 m (6.6').

8. Mains connection

cabling

The mains cable provided is thermally resistant, complying to the most recent international standards. In case of cable replacement, similar cable with comparable thermal resistant qualities must be used exclusively (cable 3x1.5 ø external 10mm (.04"), rated 300/500V, tested to 2KV, operating temperature -40°C (-40°F) +180°C (356°F))

mains connection

AR 250 can operate at voltages from 100V-115V-208V-230V-240V at 50 or 60Hz (operating voltage and frequency can be selected as described in section 6 and 18 of this manual). Prior to connecting the unit to your mains supply, ensure that the model in your possession correctly matches the mains supply available to you.

For connection purposes, ensure your plug is of a suitable rating:

at 230 V: 2 Amps on startup, 1,6 amps constant draw in normal operation
 a 115 V: 4,2 Amps on startup, 3,2 amps constant draw in normal operation

Locate the mains cable which exits the base of the unit and connect as shown below:

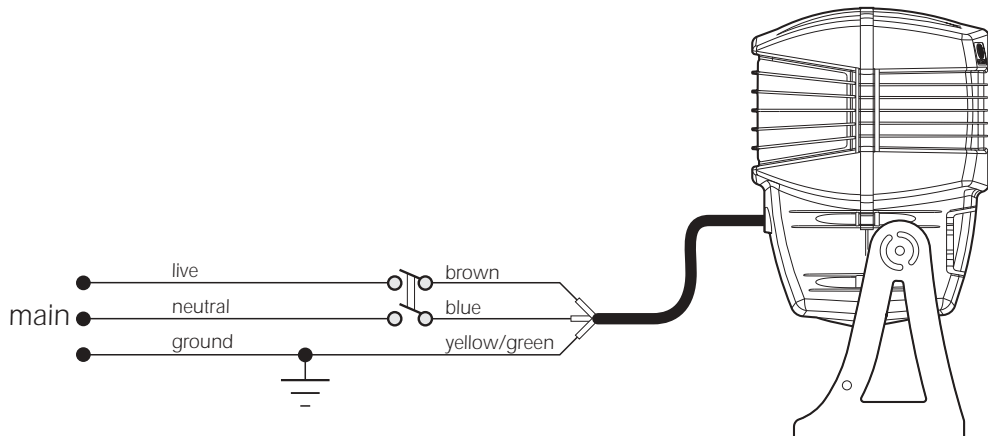

protection

The use of a thermal magnetic circuit breaker is recommended for each **AR 250**.

A good earth connection is essential for the correct operation of the fixture. Strict adherence to regulatory norms is strongly recommended.



AR 250 must be earthed; never install the unit unless the yellow/green earth cable is securely connected.

9. Signal connection

AR 250 may operate in 3 different modes:

9.1 Automated operation

9.2 Using DMX 512 signal

9.3 Synchronising AR 250 without DMX 512 signal.

Follow the instructions below which relate to your particular application:

9.1 Automated operation "solo"

AR 250 may operate in stand alone mode in the absence of control signal, using pre-programmed color changing sequence which can be activated by the multi-function panel on the unit.

9.2 Using DMX 512 signal

Control signal is digital, and is transmitted via two pair screened $\varnothing 0.5\text{mm}$ cable.

Connection is serial, utilising the data cable sockets located on the base of the AR 250.

signal connection

Connection is to international standards:

- Pin 1 gnd = shield
- Pin 2 data - = black
- Pin 3 data + = white

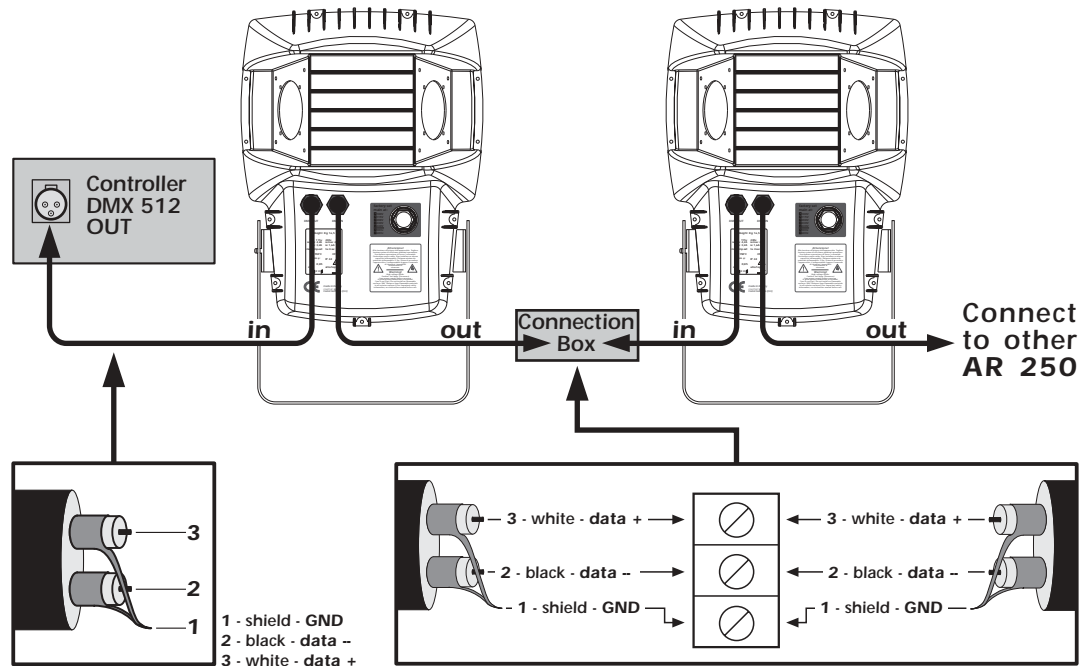

9.3 Synchronising AR 250 without DMX 512 signal.

Multiple **AR 250** units may be interconnected in the absence of DMX 512 signal, operating simply via the programs within the **AR 250**.

All **AR 250s** thus connected will operate simultaneously with one unit acting as MASTER and all subsequent units as SLAVES.

Determine which of the **AR 250s** will act as master.

Connect the projectors using the data cable (DMX OUT) of the master first unit to connect to the data cable socket (DMX IN) of the first slave, the out of this slave (DMX OUT) to the in of the second slave (DMX IN) and so on to a maximum of 10 units. Should you need to connect more than 10 units we recommend that you use a suitable dmx splitter box to achieve this. These units are usually opto-isolated and may amplify and repeat the signal as required.

Attention! We recommend that the two data cables which remain unconnected should be isolated; the data cable (DMX IN) socket of the master and the data cable (DMX OUT) socket of the last slave. Only by suitably isolating these cables will the protection rating of the unit be maintained.

Connection should be to international standards:

- Pin 1 gnd = shield
- Pin 2 data - = black
- Pin 3 data + = white

Ensure that all data conductors are isolated from one another and the metal housing of the connector.

Pin 1 should never be connected to mains power.

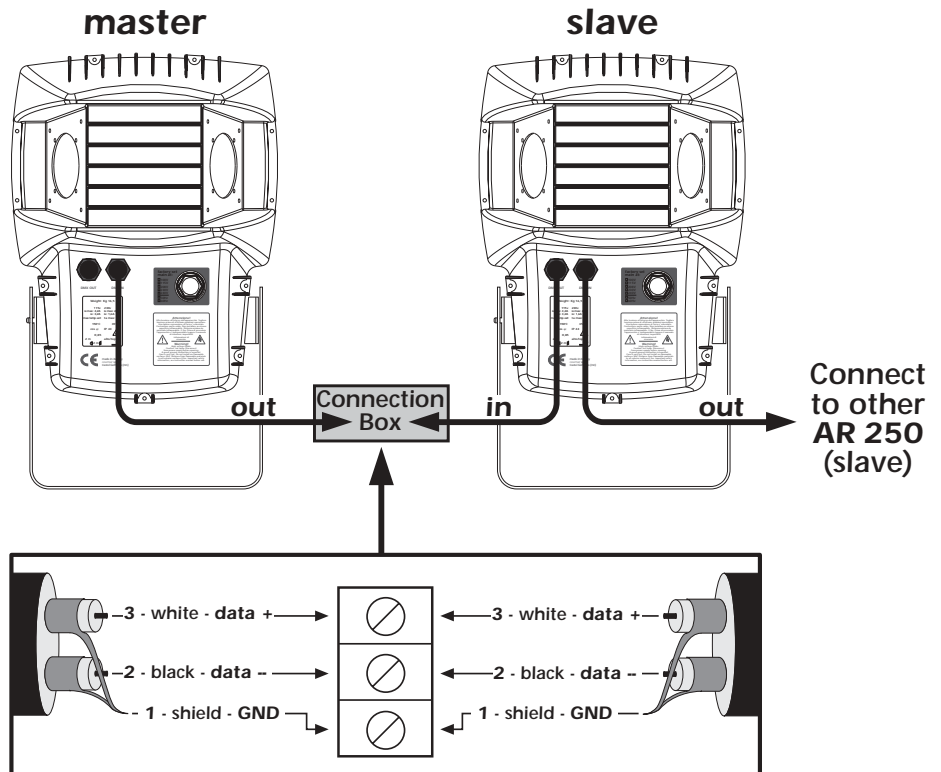

Important Information

To perform the operations which follow, from sections 10 to 18, with the exception of 17, the projector housing should be open. If you have since closed the unit up, reopen the housing as described in section 4.

10. Powering up

After having followed the preceding steps, turn on the power to the unit.

If you have chosen to control the **AR 250** using a DMX 512 controller, you should always turn on the power to the controller first.

The fixture will perform a reset function on its internal motors. This will last some few seconds, after which it will be subject to the external signal from the controller.

Software version

On powering up, the led display of the projector will display the currently installed software version for a few seconds.

For example, it may show:

R2.01 (software version 2.01).

Ventilation

The projector is fitted with 2 fans for forced cooling of the unit.

The two fans are directly controlled by the onboard software and may be switched off after powering up, depending upon the settings shown in the display. They may never be switched off when the lamp is turned on.

To turn on the fans, you will need to either alter the settings via the display panel, as described in section 11.2, or turn the lamp on.

DMX 512 signal reception

After the software version has been displayed, the projector will proceed with its reset function. On completion of this, the display will remain static on, indicating that the projector is correctly receiving DMX 512 signal.

A001 (dmx address 001).

If the display flashes, the projector is not receiving signal correctly. Check the cabling and the functioning of the controller.

turning on the power with no dmx signal connected

After the display has shown the software version, the projector will perform a reset. When completed, the display will flash to indicate the absence of **DMX 512** control signal.

messages other than A001

On powering up, the **AR 250** may display values other than A001, the **ETC** default setting.

The display may show:

DMX 512 operation

1) **A001** DMX 512 operation, address 1 (for example)

automated master/slave or automated "solo"

2) **PRG.1** master projector, program 1, auto memory stepping, adjustable.

3) **-SL-** slave projector, operation determined by the "master" unit attached

Advanced operation information on each of these modes is contained in the sections which follow.

11. DMX addressing

Each **AR 250** utilizes **6 channels** of **DMX 512** signal for complete control.

To ensure that each unit accesses the correct signal, it is necessary to correctly address each fixture. Any number between 1 and 506 can be generated via the multifunction panel of the unit **AR 250**.

This procedure must be carried out on every unit being utilized.

When powered up initially, each projector will show **A001** which indicates **DMX** address **1**; a projector thus addressed will respond to commands on channels **1** to **6** from the **DMX 512** controller. A second projector should be addressed as **7** a third as **13** and so on until the final unit has been addressed.

DMX 512 should be carried out so that there is no overlap in the assigned addresses. This will allow your controller to accurately address each individual parameter of your **AR 250s**.

altering dmx addresses

- 1) Press the + or - buttons until the display shows the DMX address required. The characters in the display panel will flash to indicate that the selection is not stored in memory.

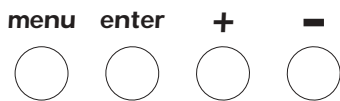

- 2) Press the enter button to confirm your selection; the display will stop flashing and the projector will now respond to the new DMX 512 settings.
- 3) To better understand the functions of each DMX 512 we refer you to section 14 "Operation via DMX 512".

Important Note: Keeping the + or - button pressed will cause the display to alter at increase speed, allowing a faster selection to be effected.

Note: Channel order and function table can be found on page 20.

12. Display panel functions

The display panel of the **AR 250** is used to display and set function information and alter various parameters. Altering the **ETC** factory settings may vary the functioning of the projector, causing it to not respond to external **DMX 512** signal. Please read and familiarize yourself with the following information very carefully before altering any selections. NOTE: the + symbol is used in these instructions to indicate the action of pressing a button as described in the text.

12.1. Operating mode (MODE)

AR 250 allows the user to select one of several operating modes:

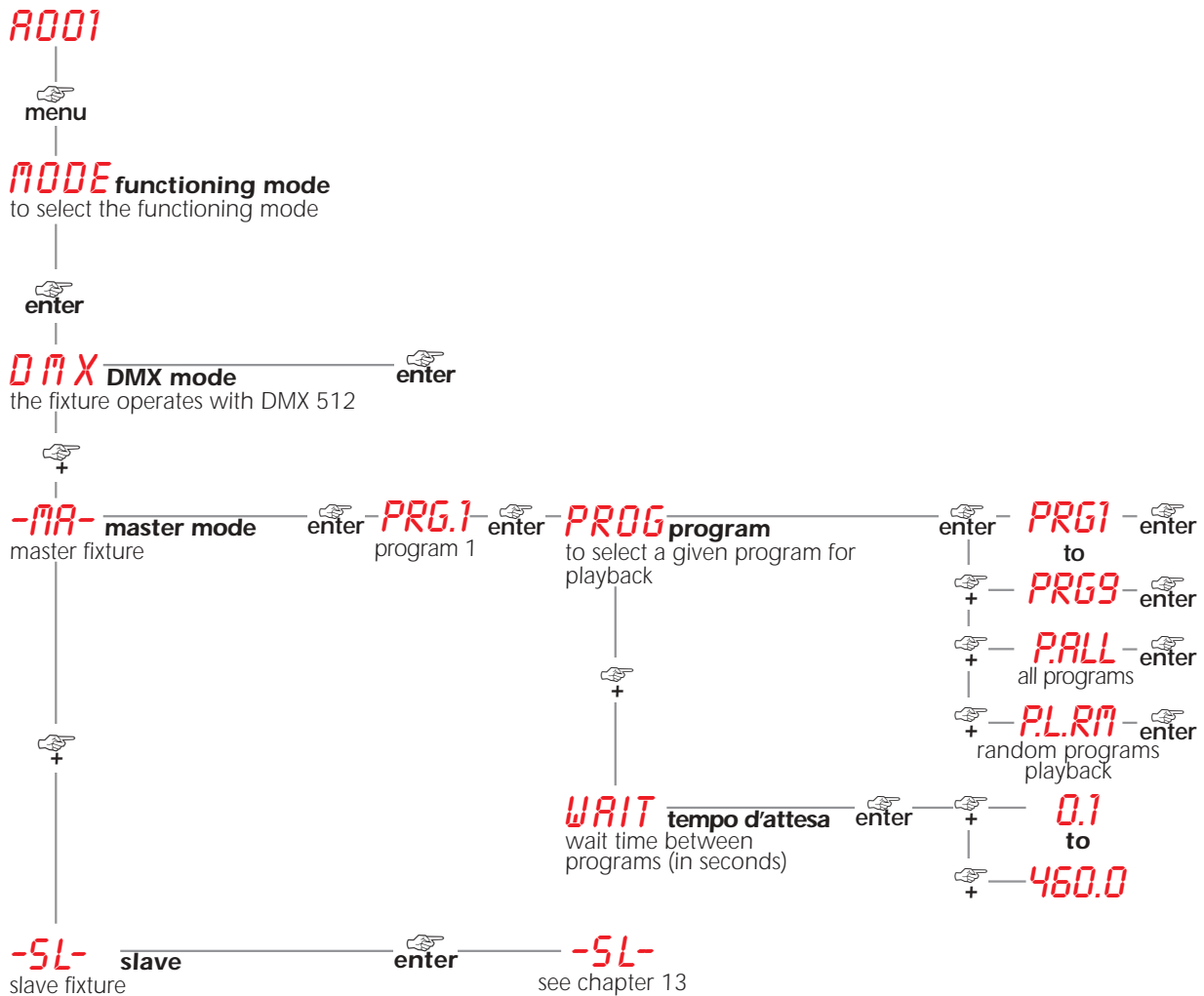

A detailed description about altering these settings may be found in sections : 13,14,15.

12.2. Functions (FUNC)

The projector allows the altering of several functions and select personalized settings.

Settings available via the "FUNC" menu are able to be altered at any time regardless of the operating mode "MODE" selected.

AD01

menu

MODE

FUNC menu funzioni
 Itthe fixture allows you to modify some of the settings in order to customize its functioning according to your needs

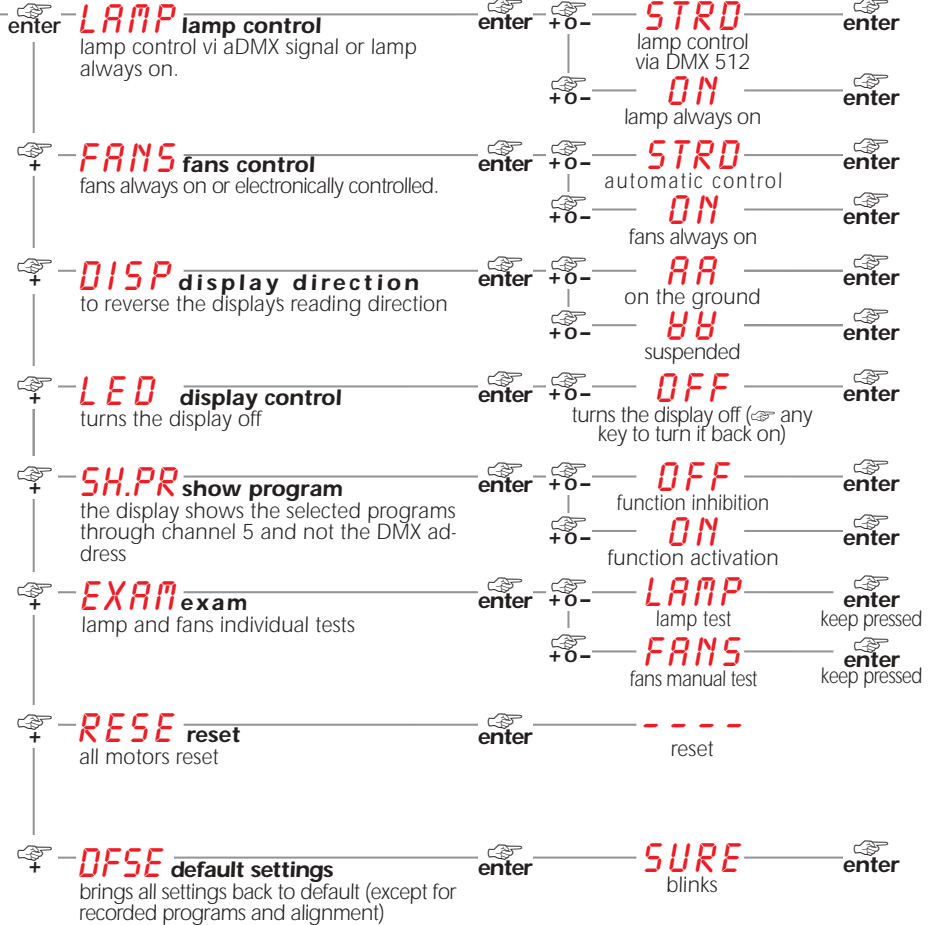

12.3. Parameters and testing (MEAS)

The internal microprocessor of the **AR 250** allows for several diagnostic and output parameters to be displayed. The **TEST** function may record, in this menu, information regarding settings to be adopted when starting up without dmX signal.

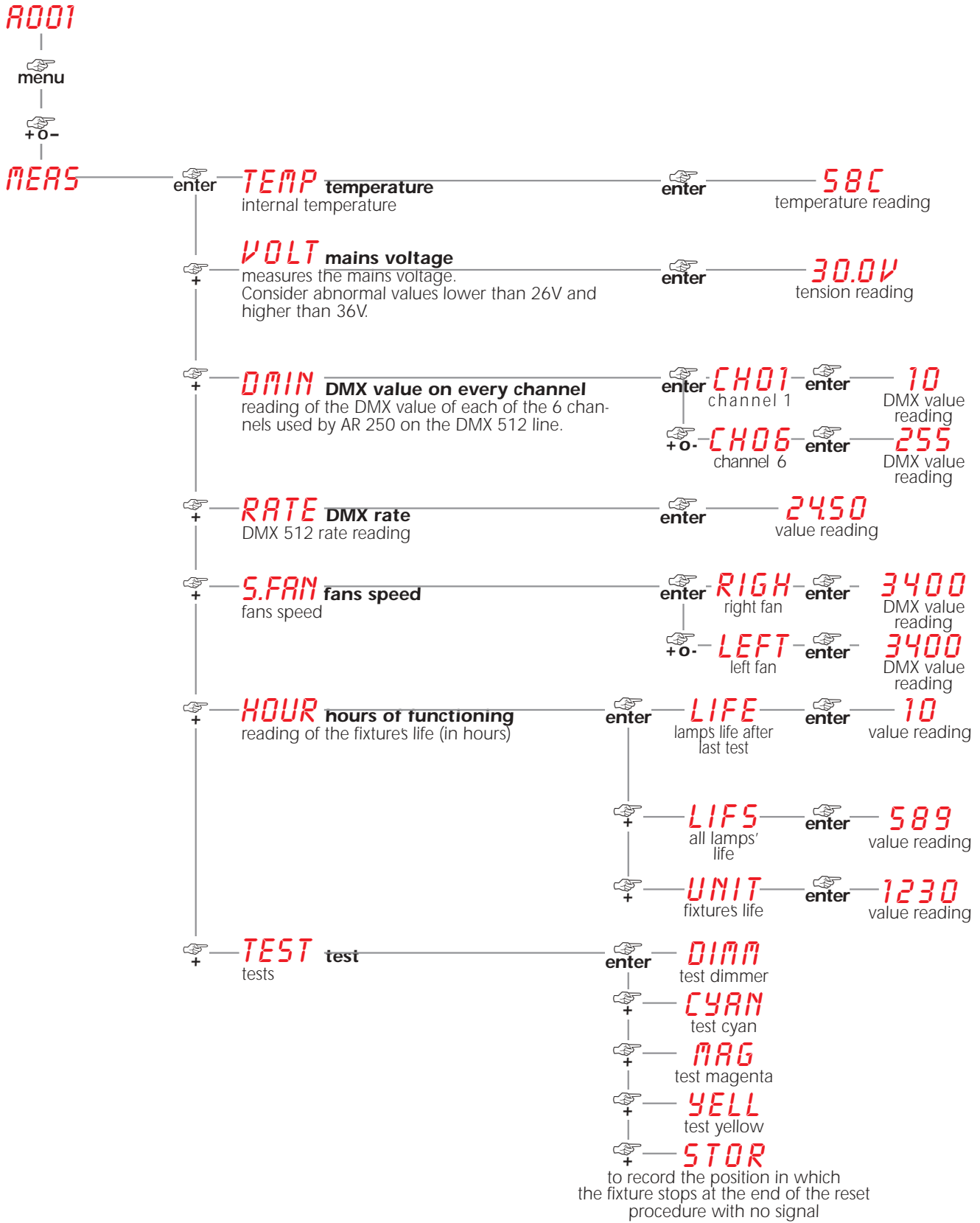

12.4. Quick guide to menu navigation

For your convenience, the following is a guide to navigating the menu system of the projector.

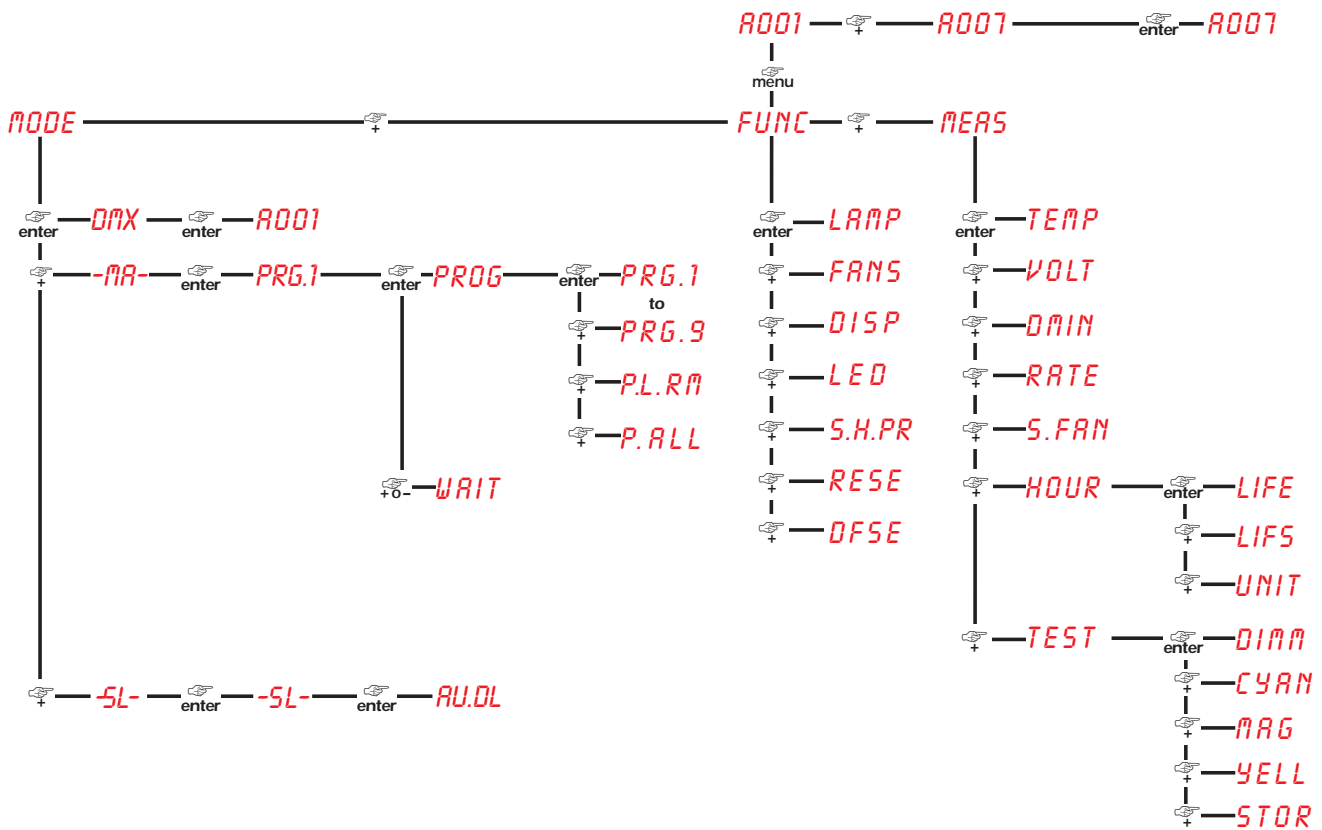

12.5. Rapid scrolling

Via the **AR 250** display, it is possible to rapidly scroll through the various numbers displayed in the menu which apply to the following 3 uses:

- 1) Pressing down and holding the + or - buttons will cause the numbers to scroll more quickly than by simply pressing buttons repeatedly
- 2) Pressing down the + button and then the - button and holding them down simultaneously will cause the numbers to jump to the highest possible value available in the particular function.
- 3) Pressing down the - button and then the + button and holding them down simultaneously will cause the numbers to jump to the lowest possible value available in the particular function.

12.6. Double pressing the menu button

Pressing the menu button twice, at any level in the navigation menu, will immediately return you to the last function in which changes were confirmed (saved).

13. Setting the unit to function automatically "solo"

AR 250 may operate automatically, carrying out pre-recorded color changes.

No cables should be connected to the data input sockets, as described in section 9.1 "automated operation "solo".

- 1) Press the **menu** button, the display will show **MODE**.
- 2) Press the **enter** button, the display will show **DMX** (for dmx function).
- 3) Press the **+** button until the display shows **-MA-** (for master).
- 4) Press the **enter** button to confirm your selection; the letters **-MA-** will flash momentarily and then the display will show the program details **PRG.**, for program,, with the relevant number (9 available programs from **1** to **9** sequentially).

You may now alter the preset parameters:

Altering the delay between color changes in a program.

- 1) The display shows **PRG.1** (program 1 is running, for example).
- 2) Press the **enter** button.
- 3) Press the **+** button until the display shows **WAIT** (wait).
- 4) Press the **enter** button. The display will show a numerical value which corresponds to the current delay between color changes
- 5) Press the **+** button to obtain the required time delay (between 0,1 and 460 seconds).
- 6) Press the **enter** button to confirm your selection. The display will flash and then return automatically to the original **PRG.1** display, recording the time delay you have selected.

Selecting an alternative program to that currently running.

- 1) The display shows **PRG.1** (program 1, for example)
- 2) Press the **enter** button.
- 3) Press the **+** button until the display shows **PROG** (program).
- 4) Press the **enter** button. The display will show a numerical value which corresponds to the currently running program **PRG1** (for example, program 1).
- 5) Press the **+** button to select the number of the required program.

The AR 250 provides numerous color change combinations in the internal memory of the projector, grouping them with consideration to the tonality and speed of the color changes:

Program 1: all possible color combinations in a smooth, slow sequence

Program 2: saturated colors in a smooth, slow sequence

Program 3: pastel colors in a smooth, slow sequence

Program 4: bright colors in a smooth, slow sequence

Program 5: all possible color combinations at a faster speed with respect to programs 1 to 4.

Program 6: saturated colors at a faster speed with respect to programs 1 to 4.

Program 7: pastel colors at a faster speed with respect to programs 1 to 4.

Program 8: bright colors at a faster speed with respect to programs 1 to 4.

Program 9: a sequence of color changes of varying tonality and speed.

- 6) Press the **+** button further and the **AR 250** will display **P.ALL** (all programs, played back in order) and **P.L.RM** (all programs, played back randomly).

N.B. Note that prior to recording, the decimal point will not appear preceding the program number.

- 7) Press the **enter** button to confirm your selection. The display will flash and display, for example, **PRG.2** recording the change you have made

NOTE: the **-** button has the effect of returning the display to the previous function.

14. DMX 512 functions

AR 250 may be controlled using the DMX 512 control protocol. Connection should be as described in section **"9.2 Operation via DMX 512"**.

If you have correctly followed all the steps described up to this point, your **DMX5 512** controller will allow you complete control of all the functions of the **AR 250** as described in the following table.

channel	function	type of control	effect	decimal	percentage
1	dimmer	step	closed	0-7	0-2.75
		proportional	from close to open	8-255	3.14-100
2	cyan	step	white clear	0-7	0-2.75
		proportional	proportional cyan control from white to cyan	8-255	3.14-100
3	magenta	step	white clear	0-7	0-2.75
		proportional	proportional magenta control from white to magenta	8-255	3.14-100
4	Yellow	step	white clear	0-7	0-2.75
		proportional	proportional yellow control from white to yellow	8-255	3.14-100
5	Auto function	step	No effects	0-9	0-3.53
		step	Auto program 1 (all colors, slow color fade)	10-33	3.9-13
		step	Auto program 2 (saturated colors, slow color fade)	34-56	13.3-22
		step	Auto program 3 (pastel colors, slow color fade)	57-79	22.3-31
		step	Auto program 4 (light colors, slow color fade)	80-102	31.3-40
		step	Auto program 5 (all colors, medium speed color fade)	103-125	40.3-49
		step	Auto program 6 (saturated colors, medium speed color fade)	126-148	49.3-58
		step	Auto program 7 (pastel colors, medium speed color fade)	149-171	58.3-67
		step	Auto program 8 (light colors, medium speed color fade)	172-194	67.3-76
		step	Auto program 9 (mixed color sequence, color fade at different speed)	195-217	76.3-85
		step	Random program	218-240	85.3-94
6	Lamp on/off/ reset	step	lamp off	0-10	0-3.92
		step	Park (no function)	11-30	4.3-11.7
		step	cmY and dimmer reset (only once)	31-45	12-17.6
		step	cmY reset (only once)	46-60	18-23.5
		step	Program stop	61-80	23.9-31.3
		proportional	Selected auto-program pause time control (1 sec/8 min)	81-241	31.7-94.5
		step	lamp on	242-255	95-100
Display panel can inhibit lamp off function					
note 1: Channel 6 has a delay time of 6 second to prevent accidental activation.					
note 2 :on/off lamp mode is not affected unless an opposite value is received					
Fixture type: AR 250			Chart name: DMX 512		
Release: 1			Date: 05/2002		

Turning on the lamp

Note that the table above indicates that to turn on the lamp channel number 7 of your DMX 512 controller should be set to between (241 and 255), to turn it off, channel 4 must have a value between 11 and 30.

You may force the lamp to turn on automatically on startup using the display panel, as described in section **"11.2 Display panel functions"** in the text describing the **"Func", lamp ON** function.

15. Operating multiple AR 250s in synchronized mode without DMX 512

Multiple **AR 250** fixtures can operate in the absence of control signal by executing internally stored, pre-recorded programs. Projectors correctly connected together may operate in synchronised mode, the **AR 250** receiving signal being denominated as "slave" units and those generating control signal designated as "master" units.

To activate this automated function, projectors must be connected together as described in the section entitled **9.3. "Synchronising multiple AR 250 fixtures without using DMX512"**; **No signal cables should be connected to the external data input sockets.**

Power up the projector and use the 4 button menu system and the display panel to set the units correctly.

15.1 "Masters"

AR 250 may operate automatically with output in the form of pre-recorded programs, as described in section "9.3. Synchronising multiple AR 250 fixtures without using DMX512". Only one unit may be designated as "master". Selecting a master unit is simply a matter of convenience and accessibility to the display panel:

- 1) Press the **menu** button, the display will show **MODE**.
- 2) Press the **enter** button, the display will show **DMX** (for dmx function).
- 3) Press the **+** button until the display shows **-MA-** (for master).
- 4) Press the **enter** button to confirm you selection; the letters **-MA-** will flash momentarily and then the display will show the program details **PRG.**, for program,, with the relevant number (9 available programs from **1** to **9** sequentially).

You may now alter the preset parameters:

Altering the delay between color changes in a program.

- 1) The display shows **PRG.1** (program 1 is running, for example).
- 2) Press the **enter** button.
- 3) Press the **+** button until the display shows **WAIT** (wait).
- 4) Press the **enter** button. The display will show a numerical value which corresponds to the current delay between color changes
- 5) Press the **+** button to obtain the required time delay (between 0,1 and 460 seconds).
- 6) Press the **enter** button to confirm your selection. The display will flash and then return automatically to the original **PRG.1** display, recording the time delay you have selected.

Selecting an alternative program to that currently running.

- 1) The display shows **PRG.1** (program 1, for example)
- 2) Press the **enter** button.
- 3) Press the **+** button until the display shows **PROG** (program).
- 4) Press the **enter** button. The display will show a numerical value which corresponds to the currently running program **PRG1** (for example, program 1).
- 5) Press the **+** button to select the number of the required program.

The **AR 250** provides numerous color change combinations in the internal memory of the projector, grouping them with consideration to the tonality and speed of the color changes:

Program 1: all possible color combinations in a smooth, slow sequence.

Program 2: saturated colors in a smooth, slow sequence.

Program 3: pastel colors in a smooth, slow sequence.

Program 4: bright colors in a smooth, slow sequence.

Program 5: all possible color combinations at a faster speed with respect to programs 1 to 4.

Program 6: saturated colors at a faster speed with respect to programs 1 to 4.

Program 7: pastel colors at a faster speed with respect to programs 1 to 4.

Program 8: bright colors at a faster speed with respect to programs 1 to 4.

Program 9: a sequence of color changes of varying tonality and speed.

- 6) Press the **+** button further and the **AR 250** will display **P.ALL** (all programs, played back in order) and **PL.RM** (all programs, played back randomly).

Note that prior to recording, the decimal point will not appear preceding the program number.

- 7) Press the **enter** button to confirm your selection. The display will flash and display, for example, **PRG.2** recording the change.

15.2 "slaves"

All projectors which are connected to a "Master" unit should be set to "Slave". Connections should be as described in section "9.3 Synchronizing multiple AR 250 fixtures without DMX 512".

"Slave" units are recognisable since they have connections made to both XLR sockets in their base, except for the final unit in the chain which has only one connection to its "DMX IN".socket.

Once this is complete, you may proceed to set up units as "Slave".

- 1) Press the **menu** button, the display will show **MODE**.
- 2) Press the **enter** button, the display will show **DMX** (for dmx function).
- 3) Press the **+** button until the display shows **-SL-** (for slave).
- 4) Press the **enter** button to confirm you selection; the letters **-SL-** will flash momentarily and then remain static.

When the display shows **-SL-** it confirms that it has accepted the setting as **Slave** and is ready to accept input instructions from a **Master** unit.

16. Resetting the electronic counter

The electronic counter should be reset to zero hours every time the lamp is changed in order to provide accurate information about lamp life

- 1) Turn off the projector.
- 2) Power up the **AR 250** while holding both the **+** and **-** buttons simultaneously.

function display

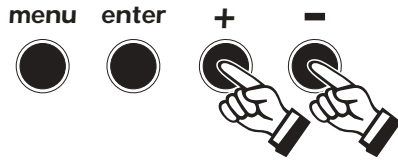

The projector will have effected a reset of the **LIFE** lamp-life counter.
To verify that the counter reset has been undertaken:

- 1) Press the **menu** button, the projector will show **MODE**
 - 2) Press the **+** or **-** button until **MERS** is displayed
 - 3) Press the **enter** button
 - 4) Press the **+** or **-** button until **HOUR** (for hour) is displayed.
 - 5) Press the **enter** button
 - 6) Press the **+** or **-** button until **LIFE** (lamp life) is displayed.
 - 7) Press the **enter** button; the display will show **0000** confirming that the counter has been reset.
- You may also verify that the other counters **LIFS** (cumulative lamp life for all lamps installed) and **UNIT** (number of hours of fixture operation) have remained unaltered.

17. Mechanical adjustments

After having powered up the projector and have established correct operation, the following mechanical adjustments should be carried out in order to maximise the output of the projector in its current installation.

17.1 Adjusting tilt angle

Loosen the two adjustment bolts on the sides of the body which allow the body to tilt (+90° -45°).



Warning: To avoid non-passive lamp failure, change lamps at rated end of life.

After having adjusted the unit to the required tilt, firmly tighten both bolts to avoid the unit slipping out of position.

17.2 Altering beam angles by inserting lenses.

Several optional and interchangeable lenses may be used to vary the beam characteristics for particular applications.

All lenses are rotatable through 360°



- Beam shape: circular
- Diffusion lens**
- 1/2 peak angle: 9,5°
- 1/10 peak angle: 20°



- Beam shape: circular
- Prismatic, semi-diffusion lens**
- 1/2 peak angle: 13,5°
- 1/10 peak angle: 31°



- Beam shape: square
- Prismatic, maximum diffusion lens**
- 1/2 peak angle: 71°
- 1/10 peak angle: 71°



- Beam shape: rectangular
- Prismatic outline/shaped lens**
- vertical projection
- 1/2 peak angle: 24°
- 1/10 peak angle: 40°
- horizontal projection
- 1/2 peak angle: 55°
- 1/10 peak angle: 68°

English

Prior to changing lenses, it is advisable to either turn off the unit or to dim the lamp.

Warning: Direct UV light exposure to the output of the unit is not recommended.

- 1) Loosen the 6 screws (A) using an appropriate screwdriver.



- 2) Rotate and remove the fixing ring.



- 3) Remove the currently installed lens.



- 4) Insert the new lens most suited to your particular application. All lenses are rotatable through 360°

- 5) After having inserted a new lens, replace the retaining ring and refasten the screws.

Care should be taken in carrying out this procedure; the seal should be correctly seated and the screws should be firmly tightened in order to maintain the protection rating of the unit.

The drain hole (see picture) should never be obstructed.

18. Altering the operating voltage and frequency (Reserved for technical staff only)

If the factory preset operating voltage and frequency do not correspond to those in use in your country of operation, you may alter the settings as described in the following paragraphs.

Incorrect selection of operating voltage and frequency will seriously compromise the functioning of the projector.

Opening up the projector

To carry out the following procedures, the projector housing should be open. Instructions for opening up the unit can be found in section 4 of this manual.

18.1 Selecting the voltage on the autotransformer

After having opened up the rear of the unit:

1) Locate the autotransformer on the left of the unit.

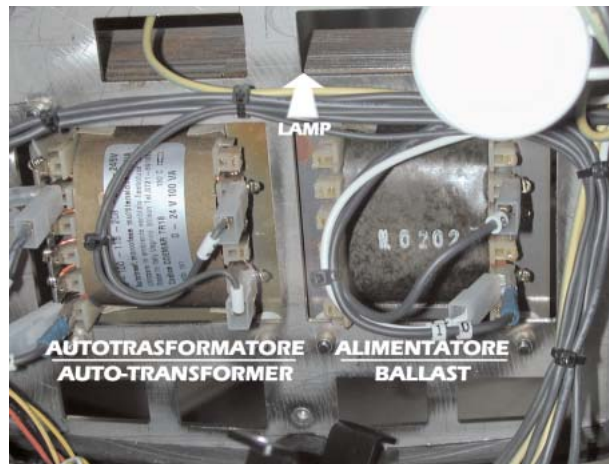

2) Select a voltage from amongst 100, 115, 208, 230 and 240V by removing cable 3 and moving it to the required voltage. To determine which is the correct tap, refer to the sticker located on the autotransformer.

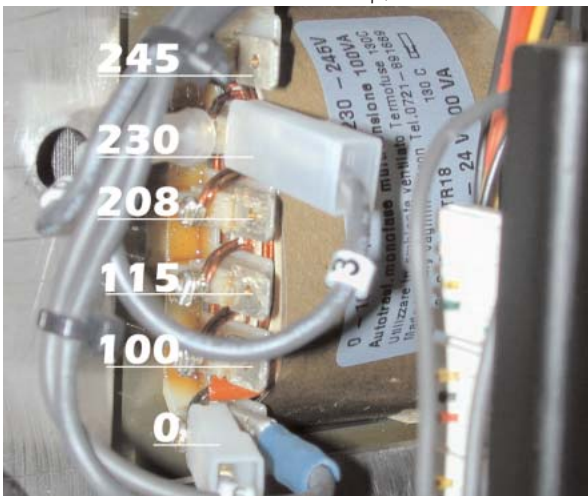

4) If the operating voltage selected is either 100 or 115V, replace the 5Amps T 250VAC 5x20mm Ceramic fuse (which is suitable for 208/230/245 V operation) with one rated at 8Amps T 115VAC 5x20mm Ceramic. The fuseholder is located near the base of the unit. The operation should be reversed if the voltage selected is either 208/230/240V, and the fuse is rated at 8Amps T.



8AT @115V

5AT @230V



5) Operating frequency may now be set (if necessary) as shown in the next section.

18.2 Selecting the frequency of the power supply of the AR 250

- 1) Locate the power supply on the right of the base.
- 2) Select from either 50 or 60Hz by moving cables #10 and #11 to the required position. To ensure you have selected the correct tap, refer to the sticker located on the power supply.



19. Opening the front of the projector (reserved for technical staff)

Several maintenance operations may require the front housing of the unit to be removed.



Warning: Remove mains power prior to opening up the unit.

The internal temperature of the unit may reach 250°C (482°F) after 5 minutes, with a peak of 350°C (662°F). Ensure that the lamp is cool prior to removing. The projector should only be opened after it has been allowed to stand and cool for 10 minutes after it has been turned off.

After having opened up the rear housing of the **AR 250** as described in section 4, proceed as follows:

- 1) Loosen the 6 screws (**A**) using an appropriate screwdriver.



- 2) Rotate and remove the retaining ring.



- 3) Remove the lens.



- 4) Remove the 2 screws (**B**).



- 5) Slide the front housing of the unit away from the rubber seal.

When replacing the housing, you must ensure that the housing (B) is seated correctly into the rubber seal (C); then replace and retighten all the screws.

Caution: The procedure must be strictly adhered to to ensure that the **AR 250** maintains its protection rating.

20. Thermal protection

A thermal sensor in the body of the **AR 250** protects the fixture against over heating.

The sensor operates by removing power to the lamp should the operating temperature exceed the factory preset. This may be due to several factors, including the lack of circulation around the unit, high ambient temperature, or the malfunction of an on-board fan. The sensor will reset itself once the temperature has returned to an acceptable level, and will continue to monitor the internal temperature of the unit.

21. Servo-controlled fans

The 2 fans are controlled by a servo-control system. The main PCB provides power to the fans and keeps track of the fan blade speed. If a discrepancy exists between the fan speed and the expected fan speed, the lamp will be automatically turned off after 5 seconds of incompatible signals.

In the case of fan malfunction, the display will show **FAER**. (fan error) after the lamp has been switched off. Should this occur, we recommend that you open up the projector housing and clean the fans thoroughly, as this is generally the main cause of problems in this area.

22. Maintenance

While every possible precaution has been taken to ensure the trouble-free operation of your **AR 250**, the following periodic maintenance is highly recommended. **Warning:** We recommend that the voltage to the unit be removed prior to any maintenance procedure taking place.

Attention

The housing may be opened as described in section 4

Periodic cleaning

Even a fine layer of dust can reduce the luminous output substantially. Regularly clean all lenses, dichroic filters and the reflector using a soft cotton cloth, dampened with a specialist lens cleaning solution.

Fans and air passages

The fans and air passages must be cleaned approximately every 6 weeks. Time between cleaning will vary due to the specific conditions in which the projector is operating. Suitable tools for performing this type of maintenance are a brush and a common vacuum cleaner or an air compressor.

The fans are located beside the lamp assembly.

Air intakes

The air intakes require regular cleaning to maximize the efficiency of the cooling system. These intakes should be cleaned approximately every 4 weeks. Time between cleaning will vary due to the specific conditions in which the projector is operating. Suitable tools for performing this type of maintenance are a brush and a common vacuum cleaner or an air compressor. Should this not suffice, it may be advisable to soak the intakes in a detergent solution.

Filters and dichroics

For a thorough cleaning of the filters and dichroic lenses, it may be best to refer the unit to trained technician, as they are located internally to the unit.

Periodic maintenance

Lamp

The lamp should be replaced at the end of its rated life if there is any observable damage or deformation due to heat. This will avoid the danger of non-passive end of life failure.

Mechanicals

Periodically check all mechanical devices for wear and tear, replacing them if necessary. Periodically check the lubrication of all components, particularly the parts subject to high temperatures. If necessary, lubricate with suitable lubricant. It is strongly suggested the use of an oil-based product rather than a greasy lubricant, to avoid the accumulation of dust and the consequent clogging of the mechanisms. Also, make sure you run this maintenance routine regularly and thoroughly.

Electronic components

Check all electrical components for correct earthing and proper attachment of all connectors, refastening if necessary.

Replacing the fuse

To replace the fuse, it is necessary to remove the rear housing, as previously described in this manual. Use a multimeter to check the fuse, replacing any faulty or damaged fuses with ones of equal value, dimensions and characteristics. These are described on the adjacent sticker.

115VAC units--Fuse 5Amp T (Time Delay) 250VAC 2x20mm Ceramic.

230VAC units--Fuse 8Amp T (Time Delay) 115VAC 5x20mm Ceramic.



Attention!

Once maintenance has been completed, ensure that all seals are replaced correctly when refitting the housing. Failure to do so will result in the unit not maintaining its protection rating and may result in damage occurring.

23. Electronic motor alignment



Attention

This section is reserved for technicians and persons with technical experience only.

The display panel on the rear of the **AR 250** allows for the electronic alignment of the projector's motors. This procedure is performed the factory. It may be useful to perform this procedure in the case of internal components being replaced. Altering the factory settings may radically alter the functioning of the projector. Carefully read all of the following prior to attempting any changes.

electronic calibration

Important Note: This procedure can only be undertaken if the projector is correctly receiving DMX 512 signal.



at the same time

0128

NOTE:

to speed up the alignment/calibration procedure it is possible to press the + and - keys at the same time to make the display jump directly to 128

Important Note: At the termination of the above electronic calibration procedure, if the END function is not performed, no memory changes will be effected. This allows the operator to abort any changes made, in case of operator error.

24 Error messages

MAER:**MASTER Error**

This message indicates that the user has attempted to set the unit to master mode while DMX signal is still being received.

SNER:**LINE SYNCH Error**

Check opto-isolator U9.

LAER:**LAMP Error**

The lamp has turned off unexpectedly, without any signal from the controller to do so. The system may have exceeded the allowable number of attempts to ignite the lamp (7) after which number the system is designed to protect ignitor, cabling and the lampholder by reducing the incidence of lamp ignition voltages to these components. Check and eventually replace the lamp if it is faulty, damaged, or has exceeded its lamp life.

EPER:**EEPROM Error**

The EEPROM is either defective or absent; refer to your **ETC** service center for a replacement component.

DTER:**DATA Error**

The EEPROM is either defective or absent; refer to your **ETC** service center for a replacement component.

FAER:**FAN Error**

The PCB generates power to the fans and monitors the fan blade speed. If there is a discrepancy between these two values (rpm and supply) the lamp power will automatically be turned off after 5 seconds of non-corresponding readings. The fan blades may need cleaning or the fan may need replacing.

The **EXAM** function in the **FUNC** sub-menu may help diagnosis.

ADER:**ADDRESS Error**

The projector is not receiving all the DMX channels necessary for its operation. Check the DMX address and the control console operation.

HEAT:**LAMP OVERHEAT Indicator**

The projector is attempting to ignite a lamp, which is still too hot to strike. Wait until the lamp has cooled further and then attempt to reignite the lamp.

25. Spare parts

Accurate description of the fixture, model number, and type will assist us in providing for your requirements in an efficient and effective manner.

Spare parts for the AR 250 are available from ETC.



Americas ■ 3030 Laura Lane, P.O. Box 620979, Middleton, Wisconsin 53562-0979 USA ■ Tel: +608 831 4116 ■ +800 688 4116 ■ Fax: +608 836 1736 ■ +800 555 8912
Europe ■ Unit 5, Victoria Industrial Estate, Victoria Road, London W3 6UU, UK ■ Tel: +44 (0)20 8896 1000 ■ Fax: +44 (0)20 8896 2000
Asia ■ Room 605-606, Tower III Enterprise Square, 9 Sheung Yuet Road, Kowloon Bay, Kowloon, Hong Kong ■ Tel: +852 2799 1220 ■ Fax: +852 2799 9325
Web: www.etconnect.com ■ Email: (US) mail@etconnect.com ■ (UK) mail@etceurope.com ■ (Asia) mail@etcasia.com
Service: service@etconnect.com ■ Toll free: 800 775 4382 ■ Comments about this document: techcomm@etconnect.com
Copyright © 2003 Electronic Theatre Controls, Inc. All Rights Reserved. Product information and specifications subject to change.
© 7095M1001 ■ Rev A ■ Released 5/31/02